

Croma Select E

Croma Select E 1jet hand shower EcoSmart 7 l/min

Surfaces: **white/chrome** Article Number: **26816400**



Description

product features

- shower head size: 110 mm
- convenient diversion via Select button
- spray type: Rain
- maximum flow rate (at 0.3 MPa): 7 l/min
- with internal water conduction
- rinseable dirt filter
- connection thread G 1/2
- connection dimension: DN15
- suitable for continuous flow water heaters

Technology



Product image



Scale drawing

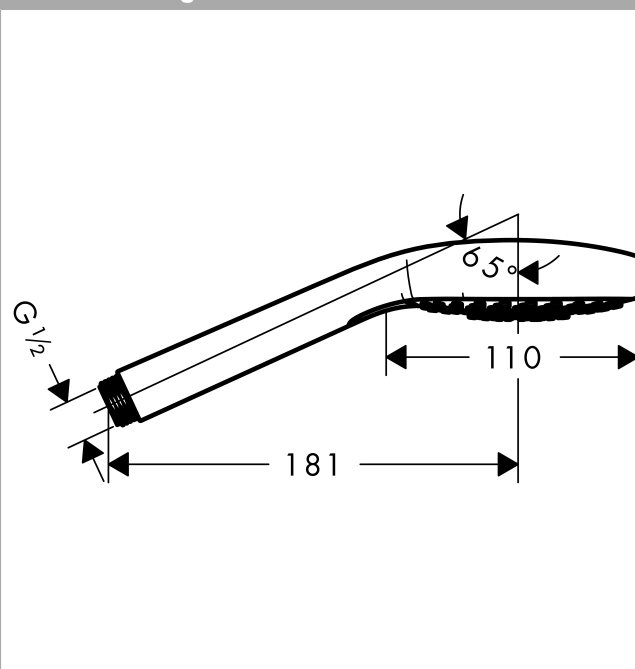

Flowchart

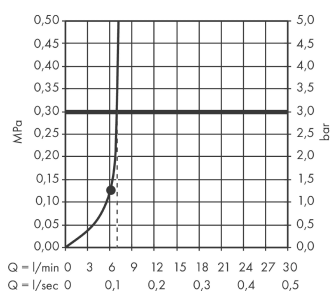

The consumption was measured in combination with the appropriate fittings (thermostat/mixer/in-wall valve) to reflect actual application in practice.